

Model : ATZ HDMI-414MPR

Description : 4-to-1 HDMI v1.4b Multi-viewer/POP 4K@30



This high performance 4×1 quad multi-viewer supports four routes HDMI High Definition input contents be displayed on one HDMI screen and one VGA screen simultaneously. It supports analog audio output that can be selected different input source. Supports five multi-view display modes. Output resolution can be adjusted and supports the maximum up to 4K30Hz. The product can be controlled via the front panel button and remote control.

Model : ATZ HDMI-414MPR

Description : 4-to-1 HDMI v1.4b Multi-viewer/POP 4K@30

Features:

- HDMI 1.4b, HDCP 1.4 compliant
- Input resolution can automate recognition. (480p~4K30Hz, 800x600~4K30Hz)
- Output resolution can be selected by on-panel button and remote control.
- HDMI supports resolution the maximum up to 4K30Hz. (3840x2160@30Hz, 1920x1080@50/60Hz, 1280x720@50/60Hz, 1920x1200@60Hz, 1024x768@60Hz)
- VGA supports resolution the maximum up to 1920x1200@60Hz. (1920x1080@50/60Hz, 1280x720@50/60Hz, 1920x1200@60Hz, 1024x768@60Hz)

Note: If output resolution selects the 4K30Hz, the VGA port will not support.

- Audio supports LPCM 2CH.
- Supports 1/2/4 windows multi-view modes.
- Control is via on-panel button and remote control.

Specifications:

Technical	
HDMI Compliance	HDMI 1.4b
HDCP Compliance	HDCP 1.4
Video Bandwidth	10.2Gbps
Video Resolutions	3840x2160@30Hz, 1920x1080@50/60Hz, 1280x720@50/60Hz, 1920x1200@60Hz, 1024x768@60Hz
Colour Depth	8-bit
Colour Space	RGB, YCbCr 4:4:4, YCbCr 4:2:2
Analog Audio Formats	LPCM2.0 44.1KHz 48KHz
ESD Protection	Human-body Model: ±8kV (Air-gap discharge) , ±4kV (Contact discharge)
Connections	
Inputs ports	4x HDMI Type A [19-pin female] 1x SEVICER [Micro USB, Update port]
Outputs ports	1x HDMI Type A [19-pin female] 1x VGA [VGA-D] 1x Audio [3.5mm Stereo Mini-jack]
Mechanical	

Model : ATZ HDMI-414MPR

Description : 4-to-1 HDMI v1.4b Multi-viewer/POP 4K@30

Housing	Metal Enclosure
Colour	Black
Dimensions	185mm (W)×128mm (D)×20mm (H)
Weight	595g
Power Supply	Input: AC100~240V 50/60Hz, Output: DC12V/1A (US/EU standards, CE/FCC/UL certified)
Power Consumption	7.68W (max)
Operating Temperature	0°C ~ 40°C / 32°F ~ 104°F
Storage Temperature	-20°C ~ 60°C / -4°F ~ 140°F
Relative Humidity	20~90% RH (non-condensing)

Operation Controls and Functions:

Front Panel:

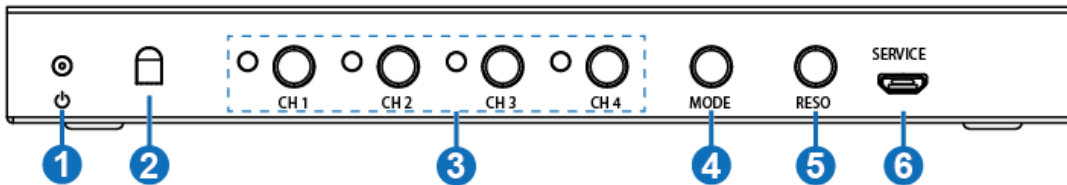

Number	Name	Function description
1	POWER LED	The LED will illuminate green when the unit is working, red when the unit is in standby mode.
2	IR	IR receiver window. It accepts the remote control signal of this device only.
3	CH1/CH2/CH3 /CH4 button	Selects input channel button (Please see "6. Display Modes" detail description).
4	MODE button	Press this button to cyclical selection display mode output (Please see "6. Display Modes" detail description). Press this button up to 5s, the output screen is full screen and equal proportion display.
5	RESO	Cycling select different output resolution. Press this button up to 5s to opening or closing window display frame.
6	SERVICE port	Firmware update used. (Manufacture use only.)

Model : ATZ HDMI-414MPR

Description : 4-to-1 HDMI v1.4b Multi-viewer/POP 4K@30

Rear Panel:

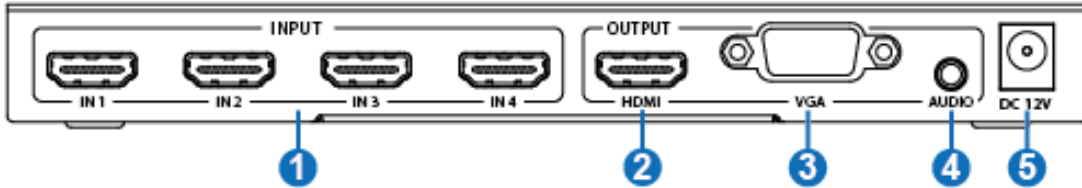

Number	Name	Function description
1	HDMI INPUT	Connect to HDMI source device such as DVD player or PS4.
2	HDMI OUTPUT	Connect to HDMI display device such as TV or Projector with a HDMI cable.
3	VGA OUTPUT	VGA output port, this port output signal is the same as the HDMI output port.
4	AUDIO OUTPUT	Analog audio output port. (Note: If the HDMI output is MODE 1, the audio output follows the video content. If the HDMI output is MODE 2/3/4/5, press CH1/CH2/CH3/CH4 up to 5s to selecting audio output or using remote control to cyclical selection audio output. The default status is CH1 screen audio output.)
5	DC 12V	Plug the 12V/1A DC power supply into the unit and connected the adapter to an AC outlet.

Model : ATZ HDMI-414MPR

Description : 4-to-1 HDMI v1.4b Multi-viewer/POP 4K@30

Display Modes:

The quad multi-viewer has 5 display modes. Please see the below detail description.

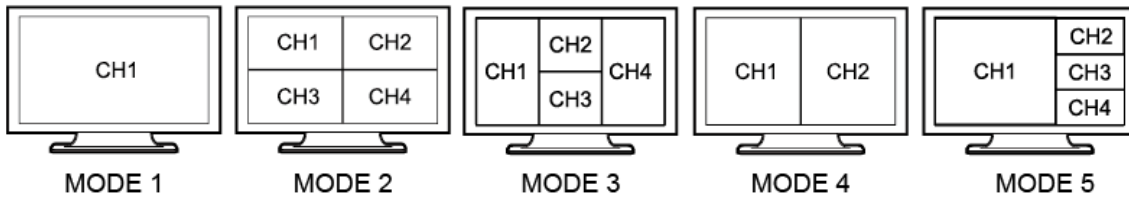

MODE 1: The quad multi-viewer will display separately four HDMI inputs. Press the CH1/CH2/CH3/CH4 buttons on-panel or using IR remote control the Source 1/2/3/4 buttons to selecting input source, corresponding on-panel light is on.

MODE 2: The quad multi-viewer divides four HD inputs with same size and display on a screen. The on-panel four lights is on. In the CH1 window, you can press the CH1 button on-panel or using IR remote control the Source 1 button to cyclical selection four inputs source. In the CH2 window, you can press the CH2 button on-panel or using IR remote control the Source 2 button to cyclical selection four inputs source...etc. The rest can be done in the same manner.

MODE 3: The quad multi-viewer divides four HD inputs and display on a screen. The on-panel four lights is on. Operation method is the same as MODE 2.

MODE 4: The quad multi-viewer divides two HD inputs with same size and display on a screen. The on-panel CH1/CH2 lights is on. In the CH1 window, you can press the CH1 button on-panel or using IR remote control the Source 1 button to cyclical selection four inputs source. On the CH2 window, you can press the CH2 button on-panel or using IR remote control the Source 2 button to cyclical selection four inputs source.

MODE 5: The quad multi-viewer divides four HD inputs and display on a screen. The on-panel four lights is on. Operation method is the same as MODE 2.

Model : ATZ HDMI-414MPR

Description : 4-to-1 HDMI v1.4b Multi-viewer/POP 4K@30

Remote Control:

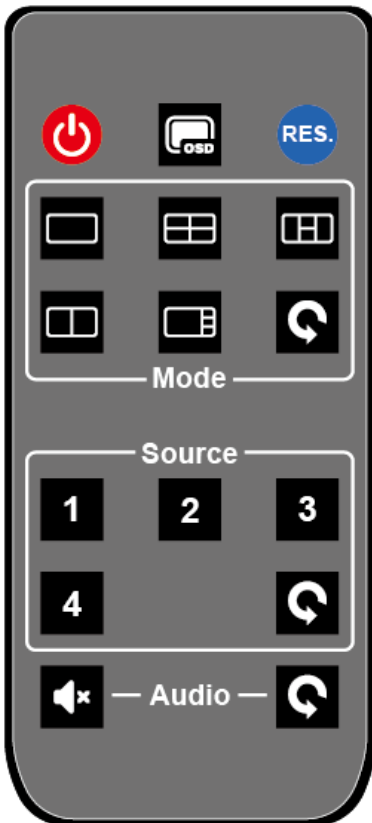

: Press this button to setting standby mode, press this button again to power on the unit.

: Press this button to opening or closing display window frame.

RES.: Press this button to cyclical selection output resolution.

Mode:

: Press these buttons to select different display modes.

Source:

1/2/3/4: Press these buttons to selecting input source.

: Press this button to cyclical selection input source (This button can be used only at the MODE 1).

Audio:

: Press this button to cyclical selection input source (This button can be used at the MODE 1 only).

Audio:

: Mute button.

: Press this button to cyclical selection audio output

Model : ATZ HDMI-414MPR

Description : 4-to-1 HDMI v1.4b Multi-viewer/POP 4K@30

Product Diagram:

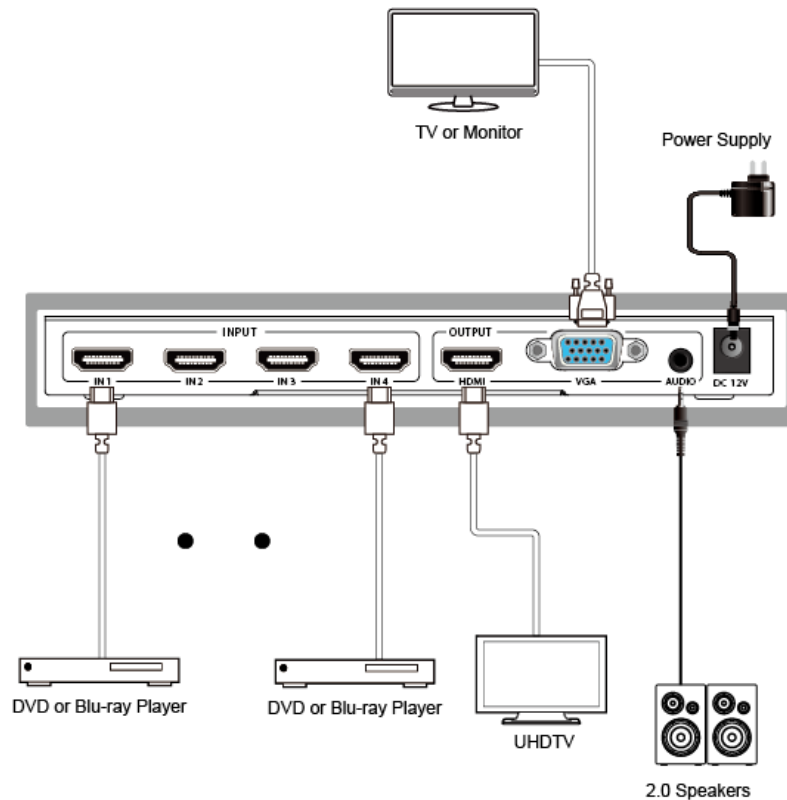

Package contents:

- 1× 4K HDMI 4×1 Quad Multi-viewer
- 1× 12V/1A DC Power Adapter
- 1× Remote Control
- 2× Mounting Ears
- 1× User Manual

Warranty: 2 years

Warranty is effective from the date of original delivery.

This warranty shall be void if a serial number has been removed from the product.

pg. 7

Notes: - All brand names and trademarks are properties of their respective holders and are referred to here for descriptive purpose only. Photo attached is for reference only, it may be slightly varied in items of colour, shape from the actual item delivered from time to time.

All specifications are subject to change without prior notice.

© Copyright ATZ